

SISTEMA DO

CATÁLOGO 2021

TARIFA

APARELEC

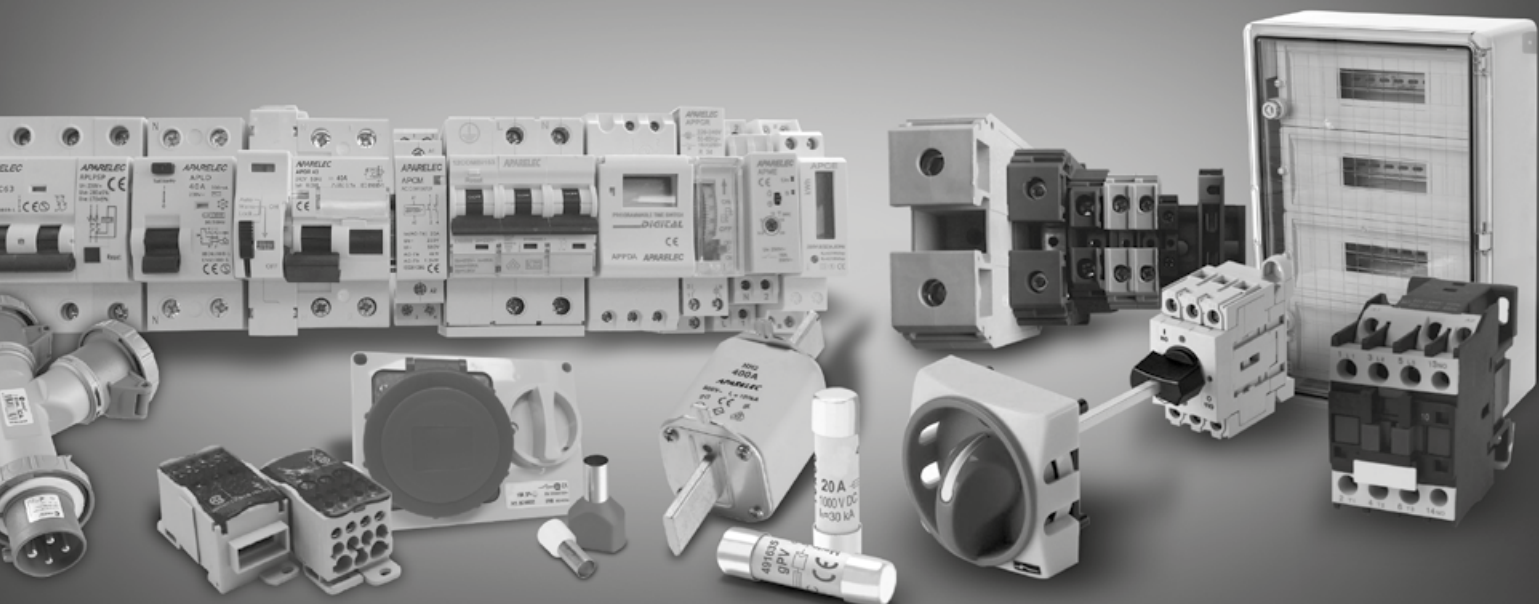



FUSIBLES DO

PRECIOS MEJORADOS

gL gG

TAMAÑOS	In (A)	UD. CAJA	U (V)	ICC (kA)	REFERENCIA
DO 1	2	10	400	50	30012.002N
	4	10	400	50	30012.004N
	6	10	400	50	30012.006N
	10	10	400	50	30012.010N
	16	10	400	50	30012.016N

NORMATIVAS:

- UNE EN 60.269
- UNE 21.103.3.1
- IEC 269.3.1
- VDE 0636/41
- DIN 49.522/24/25

PRECIOS MEJORADOS

TAMAÑOS	In (A)	UD. CAJA	U (V)	ICC (kA)	REFERENCIA
DO 2	20	10	400	50	30112.020N
	25	10	400	50	30112.025N
	35	10	400	50	30112.035N
	50	10	400	50	30112.050N
	63	10	400	50	30112.063N



PRECIOS MEJORADOS

TAMAÑOS	In (A)	UD. CAJA	U (V)	ICC (kA)	REFERENCIA
DO 3	80	10	400	50	30212.080N
	100	10	400	50	30212.100N

Notas



REF. 311.132.TP



REF. 311.112.BN

BASES DO

TAMAÑOS	In (A)	POLOS	CONEXIÓN	MAT. CUERPO	UD. CAJA	FIJACIÓN	REFERENCIA
D01	16	1P	Tornillo-Tornillo	Cerámico	20	Rail Din	310.111.BN
D01	16	1P	Tornillo-Tornillo	Cerámico	20	Tornillo	310.121.BN
D01	16	3P	Tornillo-Tornillo	Cerámico	5	Rail Din	310.211.BN
D01	16	3P	Tornillo-Tornillo	Cerámico	5	Tornillo	310.221.BN
D02	63	1P	Brida-Brida	Cerámica	20	Rail Din	311.112.BN
D02	63	1P	Brida-Brida	Cerámica	20	Tornillo	311.122.BN
D02	63	1P	Pletina-brid	Plástico	20	Pletina	311.132TP
D02	63	3P	Brida-Brida	Cerámico	5	Rail Din	311.212.BN
D02	63	3P	Brida-Brida	Cerámico	5	Tornillo	311.222.BN
D03	100	1P	Brida-Brida	Plástico	10	Rail Din	211200
D03	100	1P	Brida-Brida	Plástico	10	Tornillo	210200
D03	100	1P	Pletina-brid	Plástico	10	Pletina	312.133.BP



TAPONES ROSCADOS DO

TAMAÑOS	In (A)	ROSCA	UD. CAJA	REFERENCIA
DO 1	16	E 14	20	315.11.TBN
DO 2	63	E 18	20	316.11.TBN
DO 3	100	M 30	10	317.11.TBN



TAPAS PROTECTORAS DO

TAMAÑOS	In (A)	POLOS	UD. CAJA	REFERENCIA
DO 1 / DO 2	16 / 63	1P	20	331.TABN19
DO 3	100	1P	20	332.TABN19
DO 1 / DO 2	16 / 63	3P	20	333.TABN19

DO 1 16A 400V

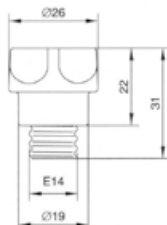

DO 2 63A 400V



DO 3 100A 400V

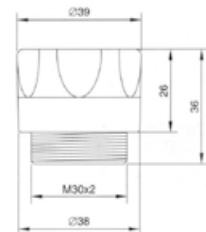

ANILLOS DE AJUSTE DO



TAMAÑOS	In (A)	UD. CAJA	REFERENCIA
DO 1	2	10	300AAJ002N
DO 1	4	10	300AAJ004N
DO 1	6	10	300AAJ006N
DO 1	10	10	300AAJ010N
DO 2	20	10	301AAJ020N
DO 2	25	10	301AAJ025N
DO 2	35	10	301AAJ035N
DO 2	50	10	301AAJ050N
DO 3	80	10	302AAJ080N

ANILLOS DE ADAPTACIÓN DO
(PARA COLOCACIÓN FUSIBLES DO 1 EN BASE DO 2)

TAMAÑOS	In (A)	UD. CAJA	REFERENCIA
DO 1	2	10	300AAD002N
DO 1	4	10	300AAD004N
DO 1	6	10	300AAD006N
DO 1	10	10	300AAD010N
DO 1	16	10	300AAD016N



MUELLE DE ADAPTACIÓN DO
(PARA COLOCACIÓN FUSIBLES DO 1 EN TAPONES DO 2)

TAMAÑOS	In (A)	UD. CAJA	REFERENCIA
DO 1	2 - 16	10	300MADAPTA

Base DO1 16A 400V~

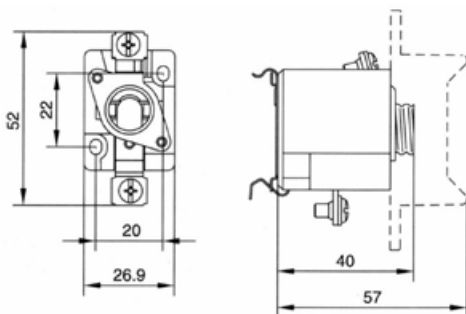

Base DO 3 100A 400V~

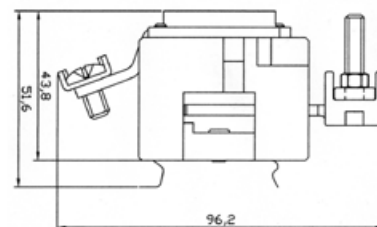
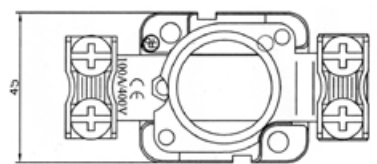

Base DO2 63A 400V~

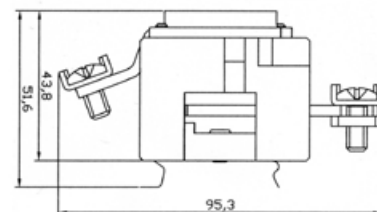
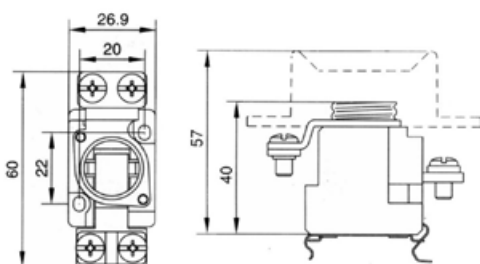

CONDICIONES GENERALES DE VENTA

PEDIDOS MÍNIMOS

Pedidos mínimos de 100 € netos.

PRECIOS

Se aplicarán los precios y descuentos vigentes en el momento de formalizar el pedido.

EMBALAJES

La mercancía se suministra en los envases estándar completos indicados.

PORTES

Península

100 € - 299 € (opcional 7,99 € cargados en factura)

+ 300 € (portes pagados)

Baleares

100 € - 499 € (opcional 16,95 € cargados en factura)

+ 500 € (portes pagados)

Canarias, Ceuta y Melilla

+ 900 € (portes pagados)

DEVOLUCIONES

Toda devolución y condiciones deberán ser aceptadas previamente por APARELEC BCN, S.L., y comunicada antes de 15 días posteriores a su recepción.

PLAZO DE ENTREGA

El requerido por el comprador.

En caso contrario se considerará 7 días desde la recepción del pedido.

CONDICIONES GENERALES

APARELEC BCN, S.L., se reserva el derecho de modificar los precios y/o las características técnicas de los productos de esta tarifa sin previo aviso.

APARELEC BCN, S.L.

C/ Cobalt, 28

08940 Cornellá de Llobregat (Barcelona)

T. 934 753 470 · F. 934 800 580

aparelecbcn@aparelecbcn.com

www.aparelecbcn.com